

# Viking Presidential

Version: 1.0

## INTRODUCTION

The Presidential Shake is the original luxury shingle created to replicate the look of cedar shakes with the performance of fibre glass construction. Presidential Shake shingles deliver the charm and character of hand-split wood shakes with the durability and strength that presides over wood in virtually every surrounding.

## PROPERTIES

Presidential Shake shingles are composed of fibreglass mat base. Ceramic-coated mineral granules are tightly embedded in carefully refined, water resistant asphalt.

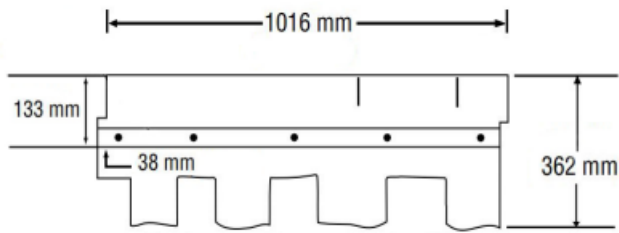

Figure 1

Weight/Square (approx)	17kg/m <sup>2</sup>
Dimensions (overall)	362mm x 1016mm
Weather Exposure	100mm

Standard Colours	Product Code	Install coverage
Weathered Wood	DDB270	1.86m <sup>2</sup>
Charcoal Black	DDB275	1.86m <sup>2</sup>

## APPLICABLE STANDARDS

ASTM D 3018, Type I

ASTM D 3462 ASTM E 108 Class A Fire Resistance

ASTM D 3161 Class F Wind Resistance

ASTM D 7158 Class H Wind Resistance

UL 790 Class A Fire Resistance

ICC-ES Evaluation Report ESR-1389

ICC-ES Evaluation Report ESR-3537

CSA Standard A123.5

BRANZ Appraisal Certificate No 276

## INSTALLATION

Installation instructions including diagrams, are supplied on each bundle of Presidential Shake shingles, or separate installation guides can be obtained by contacting Viking Roofspec. Below information is not explicit and Presidential Shake installation manual must be referred to, before installing the product, or separate installation guides can be obtained by contacting Viking Roofspec.

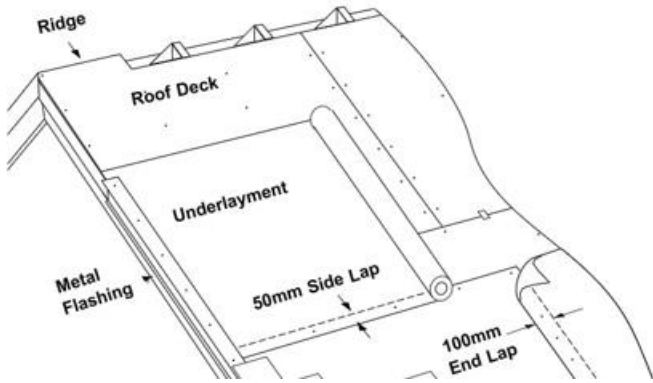

## ROOF DECK REQUIREMENTS

Apply shingles to a minimum of 15mm thick plywood, or 16.3mm H3.1 treated Superstrand Sarking. Please see refer to the Viking CertainTeed substrate check list.

## VALLEYS

Valley liner must be applied before shingles. Open valleys are recommended; however, closed-cut valleys are also acceptable. Woven valleys are not recommended when applying Presidential. The closed-cut valley application method is recommends using Viking Peel & Stick Waterproofing Underlayment to line the valley prior to being fully covered by the shingles. Open valleys require to be lined with **Viking Peel & Stick** below the valley iron.

## VENTILATION

To best ensure adequate ventilation, use a combination of continuous ridge ventilation, incorporating an external baffle, and balanced drip edge ventilation. At the gable ridge, leave a minimum 150mm substrate unvented. See Figure 2.

## UNDERLAYMENT

At standard slopes (18° or greater) a single layer of Viking Synthetic Roofing Underlay, Viking Peel and Stick Waterproofing Membrane or Viking approved underlayment is recommended. A corrosion-resistant drip edge is recommended and should be placed over the underlayment at the rake and beneath the underlayment at the eaves.

On low slopes (10-18°) apply Viking Peel & Stick Waterproofing Shingle Underlayment or two layers of 900mm wide felt shingle underlayment lapped 450mm, over the entire deck according to the application instructions provided with the product. When Peel & Stick is applied to the rake area, the drip edge may be installed under or over the membrane. At the eave, the Peel & Stick is to be installed over the flashing.

In areas prone to snow, ice or driving rain; Viking Peel and Stick Waterproofing Membrane or an approved equivalent must be used. Two layers of Viking Synthetic Roofing Underlay is not acceptable for these situations.

## FASTENINGS

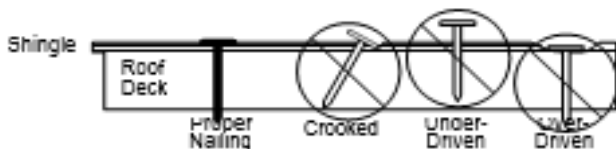

Figure 3

**IMPORTANT:** For decks 19 mm thick or thicker, nails must go at least 19 mm into the deck.

On thinner decks, nails must go at least 3.2 mm through the deck.

Nails must be 11- or 12-gauge roofing nails, corrosion-resistant, with at least 9.5 mm heads, and at least 32 mm long.

**NOTE:** Nails are required for Presidential; staples are not an acceptable fastener.

**LOW AND STANDARD SLOPE:** For low and standard slopes, use five nails for each full Presidential shingle as shown below.

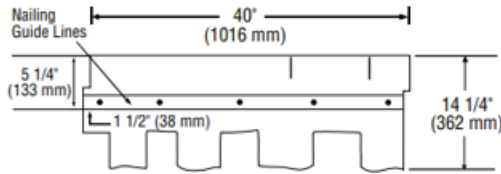

Note: Apply fasteners in the middle of the nail lines.

Figure 4: Fastening Presidential and shingles on low and standard slopes.

**FOR STEEP SLOPES and HIGH/EXTRA HIGH WIND:** use nine nails for each full Presidential shingle and apply 25mm diameter spots of asphalt roofing cement under each shingle tab. After applying 5 nails in between the nailing guide lines, apply 4 nails 25mm above tab cutouts making certain tabs of overlying shingle cover nails.

**Important:** Failure to follow these steep slope instructions can void the warranty in the event of shingle delamination.

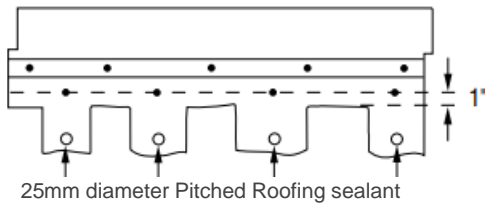

Figure 5: Fastening Presidential

**Caution:** Excessive use of Pitched roof sealant can cause shingles to blister.

## PREPARING THE DECK

Apply underlayment as required, Viking Synthetic Roofing Underlay, Viking Peel and Stick Waterproofing Membrane or a Viking approved alternative. Apply flat and unwrinkled. Snap horizontal and vertical chalk lines to assure shingles will be correctly aligned. Exposure is 102mm.

## PRESIDENTIAL STARTER

Use TWO (2) OVERLAPPING LAYERS of CertainTeed's "Presidential Starter" shingles, applied in the following fashion, starting at left rake/eaves corner. Starting at the right rake/eaves corner is not permitted. The staggered top edge of the starter pieces will allow a smooth and uniform transition for applied shingles.

1. Bottom Starter Course Layer: Cut 20" off the first bottom piece. Apply remaining 336mm x 538 piece, followed by full 336mm x 1016mm pieces along the eave. **DO NOT REMOVE THE PERFORATED TOP SECTION.** Extend the shingles over the rake and eaves about 13 mm if drip edge is used, or 19 mm if no drip edge is used.

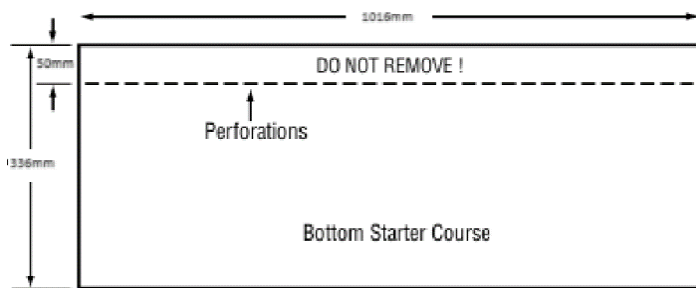

Coloured granules matching the shingle blend are to be exposed at the lower edge of the roof.

Figure 6: Bottom Starter course

2. Top Starter Course Layer: Remove the 50mm perforated top section. Cut 50mm off the left side of the first top piece only. Install the 286mm x 966mm piece over and flush to the bottom starter course. Continue with 286mm x 1016mm top course pieces over the rest of the bottom starter course.

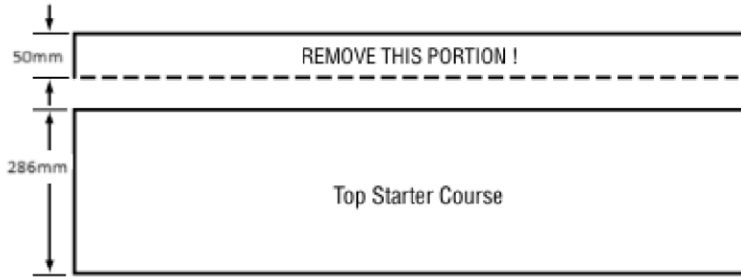

Figure 7: Presidential starter, top course

NOTE: The exposed coloured granules on the “top” starter shingles must match the Presidential shingle colours.

Fasteners should be placed about 25mm and 330mm in from both ends of a full-length starter shingle. Fasteners for less than full 1016mm starter shingles should be placed about 25mm in from each end and evenly spaced no more than 330mm apart (2, 3 or 4 fasteners may be used on shorter starter shingles depending on the length.)

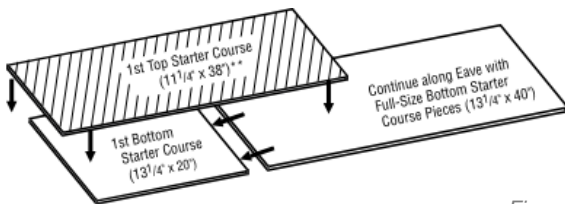
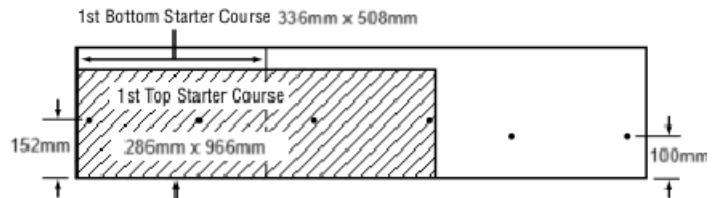

Figure 8



- Extend the shingles over the rake and eaves about 13 mm if drip edge is used, or about 19 mm if no drip edge is used.
- Continue along eave with 286mm x 1016mm Top Starter Course shingle, butted against the in-place Top Starter Shingles and Flush to the Lower Edge of the Bottom Starter.

**Application (Metric-Sized Shingles)**

The recommended application method is the Five Course, Diagonal Method (Metric) found on each bundle of shingles, see figure 2. In this method, shingle course offsets as displayed below. These shingles may be used for new construction or for re-roofing over old metric-sized shingles. (Special conditions apply)

5" AND 15" OFFSET, FOUR-COURSE DIAGONAL METHOD

1ST COURSE:

Start at left rake, hip or valley and apply a full shingle.

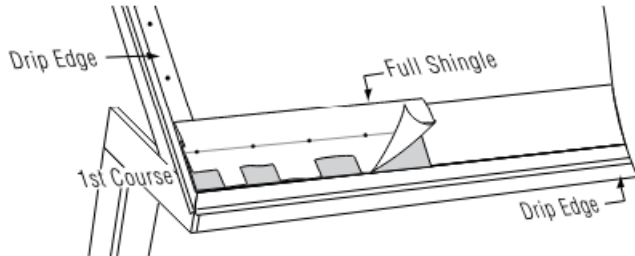

Figure 9.1

2ND COURSE:

Cut 127mm from the left edge of the first shingle. Install the remaining 889mm piece by lining up the right lower edge with the 140mm alignment notch in the top of the First Course shingle.

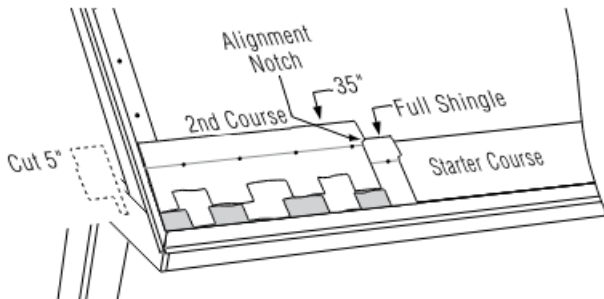

Figure 9.2

3RD COURSE:

Cut 548mm from the left edge of the first shingle. Install the remaining 508 piece by lining up the right lower edge of the shingle with the 394mm alignment notch in the top of the Second Course shingle.

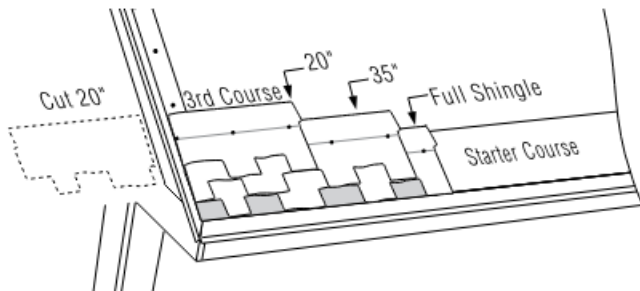

Figure 9.3

4TH COURSE:

Cut 635mm from the left edge of the first shingle. Install the remaining 381mm piece by lining up the right lower edge of the shingle with the 140mm alignment notch in the top of the Third Course shingle.

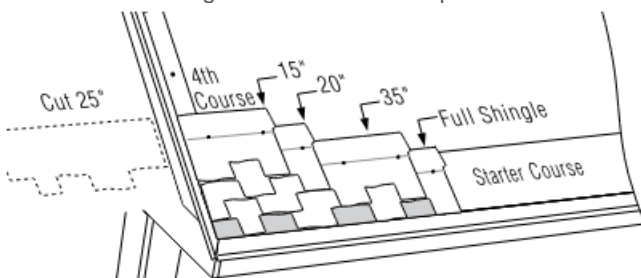

Figure 9.4

SUCCEEDING COURSES:

Start the Fifth Course by installing a full shingle and repeat the four-course pattern. Continue applying shingles filling into the right of the first four courses.

**IMPORTANT:** The designed appearance and service of Presidential Shake Shingles requires strict adherence to the application instructions.

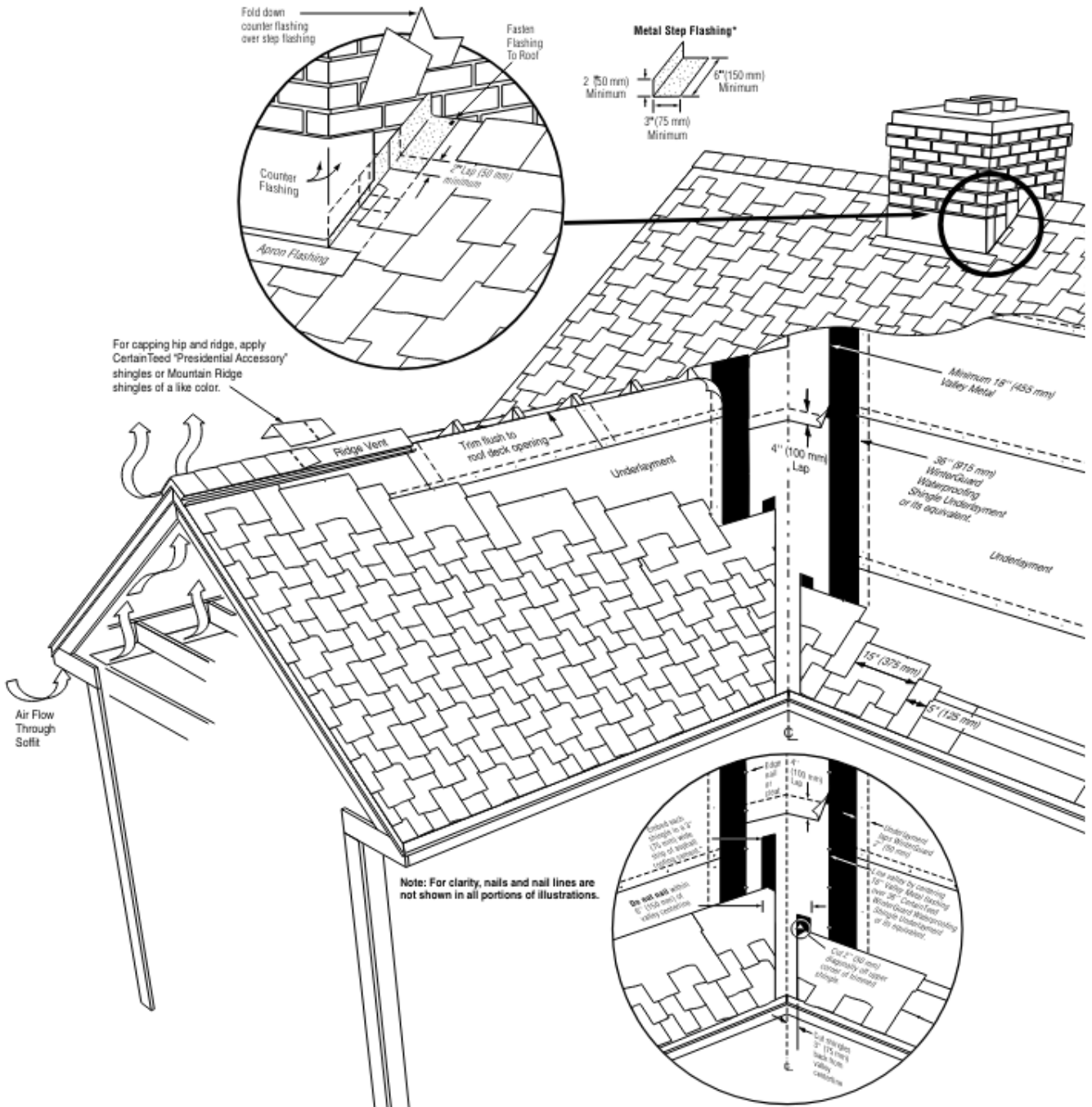

Figure 10

**Flashing**

Use corrosion-resistant metal flashing.

**Step Flashings**

Flashing must consist of a 127mm x 153mm piece, bent as shown in Figure 11. Place each piece of flashing 50mm up the roof from where the lowermost edge of the next (overlapping) shingle will be applied. Each succeeding course of flashing must “overlap” the flashing course below it a minimum of 50mm.

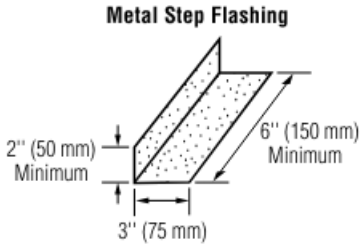

Figure:11

**Hips and Ridges**

Use Cedar Crest® accessory shingles to cover hips and ridges. Carefully separate the three-piece units prior to application, by first folding along the pre-cut lines and then detaching the pieces (see Figure below). No cutting is necessary. There are 30 individual shingles (10 three-piece units) in each bundle. One bundle will cover 6m. Each 300mm x 300mm shingle has a shadowline that is a design feature which is visible when applied properly. To prevent shingle damage during application, they must be sufficiently warm to allow proper forming.

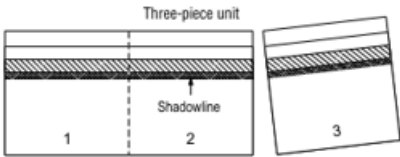

Figure 12: Separate to make 3 cap shingles

**FASTENING IMPORTANT:** Use TWO nails to fasten each shingle. Fasteners must be minimum 50mm long. For the starter shingle, place fastener 25mm in from each side edge and about 50mm up from the starter shingle’s exposed butt edge, making sure fastener goes 20mm into the deck or all the way through the deck. (see Figure 13). For each full Cedar Crest shingle, place fasteners 143mm up from its exposed butt edge and 25mm in from each side edge (see Figure 14).

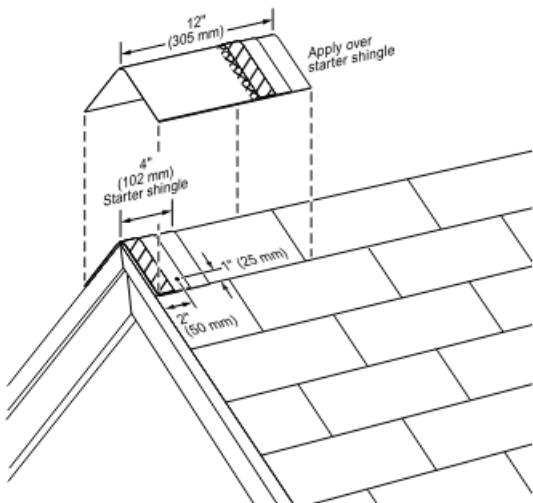

Figure: 13

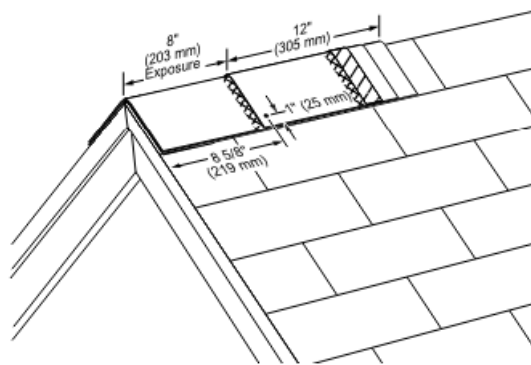

Figure: 14

## CEDAR CREST® APPLICATION

- Apply primary roofing up to hip or ridge on both sides of roof and trim flush. Ensure that the Cedar Crest shingles will adequately cover the top course of the shingles on both sides of the hip or ridge.
- Prepare a 100mm “starter” shingle by cutting off the lower 200mm colour granule portion of one Cedar Crest shingle.
- Apply the 100mm starter piece with raised overlay edge over the bottom corner of the hip or to either end of the ridge, overhanging the corner or end by approximately 12mm and bending the starter shingle along its centreline to form into place (see Figure 13).
- Install a nail on each side about 50mm up from the starter shingle’s exposed butt edge and 25mm in from each side edge of the shingle. Then apply a full piece over the starter, bending the shingle along its centreline and forming it into place over the hip or ridge, flush with the bottom and side edges of the starter shingle.
- Fasten with two nails minimum 50mm long with one nail on each side of shingle 220mm up from the butt edge and 50mm in from each side edge (see Figure 14)
- Continue application of Cedar Crest shingles up the hip or along the ridge, forming each shingle over the hip or ridge, and fasten as shown in Fastening. Expose Cedar Crest shingles 203mm, covering all fasteners.
- Add a Dab of pitched roof sealant between the shingle layers.
- To assist in proper alignment, snap a chalk line (not red) parallel to the hip or ridge applying along the line where the side edges of the Cedar Crest shingles should be.

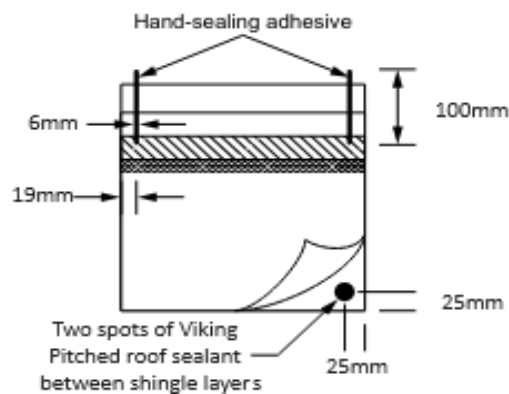

Figure: 15

### IMPORTANT:

High and Extra Wind Instructions.

In order to achieve the High and Extra High wind rating, each “hip and ridge” shingle must be both 1) fastened with nails as shown and 2) hand-sealed with two 6mm wide beads of Viking pitched roof sealant applied from the middle of the shingle’s raised overlay on the top piece and extending approximately 100mm along the sides of the headlap along a line 19mm from each side edge of the shingle’s headlap as shown in figure 12. Immediately align and apply the next overlying shingle, gently pressing tab sides into adhesive. Only one side of the double thickness tab is laminated together; to secure the other side, after folding the shingle over the ridge and nailing into position, a 25mm spot of pitched roof sealant must be applied between the shingle layers as shown. Immediately align and apply the next overlying shingle, gently pressing tab sides into adhesive.



June 2024

## PRODUCT DATA SHEET



### Cleaning and Maintenance

Please refer to the CertainTeed Cleaning and maintenance guide.

N.B If potable water is being collected from the roof, disconnect all down pipes prior to applying the chlorine solution. Viking Roofspec does not recommend the use of any other alternative form of treatment.

### Precautions

**Order for the entire project all at once:** To ensure the best colour match for your whole roof, order everything you need all at once. If you do require more stock for a project, please tell customer services that you have had a previous order and want to order from the same batch.

- **Follow Manufacturer's Instructions:** Always refer to the installation instructions provided by CertainTeed for the Landmark shingles. With Viking Roofspec standard details, these instructions detail the specific requirements and recommendations for installation. There is a basic install at the back of every pack.
- **Check Weather Conditions:** Ensure that the weather conditions are suitable for installation. Avoid installing shingles during extremely hot or cold temperatures, high winds, or precipitation, as these conditions can affect the integrity of the installation. If the packs are too cold you will need set them out in the sun for a bit to allow them to find their natural form.
- **Prepare the Roof Deck:** The roof deck should be clean, dry, and free from any debris or protrusions that could affect the installation or the performance of the shingles. Repair any damaged areas of the roof deck before installing the shingles. Deck should be 18% or less moisture content. Substrate must be installed in a brick bond pattern. Substrate to be installed perpendicular to the rafters.
- **Use Proper Fasteners:** Use the recommended nails or fasteners specified for the Landmark shingles. Proper fastening is essential to ensure that the shingles are securely attached to the roof deck and can withstand wind uplift. Ensure that you use the right nails grade for the corrosion zone. Use the right number of fixings and fixing patterns for the required wind zone.
- **Install Underlayment:** Install an appropriate underlayment beneath the shingles to provide an additional layer of protection against moisture infiltration and to enhance the roof's waterproofing. Minimum 100mm overlap for joints.
- **Follow Correct Installation Technique:** Install the shingles according to the recommended technique, including the proper overlap and alignment. Ensure that each shingle is properly positioned and fastened to prevent water intrusion and wind damage.
- **Apply Sealant:** Use Viking pitched roof sealant to seal around flashing, vents, and other roof penetrations to prevent water leakage.
- **Inspect Regularly:** After installation, perform regular inspections of the roof to check for any signs of damage or deterioration. Promptly repair any issues to maintain the integrity of the roof system.

### STORAGE

Handling and storage of all materials whether on or off site is under the control of the Viking Roofspec Licensed and Trained Installers. Dry storage must be provided for all products, do not let products get crushed under weight of stacking pallets on top of each other.

#### Auckland office

80 Alexander Crescent,  
Otara PO Box 14-541,  
Panmure, Auckland  
1741, New Zealand

#### Christchurch office

2 Nazareth Avenue,  
Middleton, PO Box  
9117, Tower Junction  
Christchurch 8149,  
New Zealand

#### Wellington office

19 Pretoria St,  
Lower Hutt 5010,  
New Zealand

T: 0800 729 799

F: 0800 729 788

[info@vikingroofspec.co.nz](mailto:info@vikingroofspec.co.nz)

[www.vikingroofspec.co.nz](http://www.vikingroofspec.co.nz)

A division of Viking Group Limited